

Technical Specifications



KN3C series - Standard toggle switches

Technical Information:

Rating:	20A 125 VAC / 15A 250 VAC
Termination:	6.3mm tab terminals (accepts 6.3mm push-on lugs)
Mounting:	M12x0.75 threaded collar (mounts through \varnothing 12.2mm panel hole)
Dielectric strength:	1500VAC (1 minute)
Configurations:	On-On and On-Off (2 position), On-Off-On (3 position)
Switch:	SPST, SPDT, DPST, DPDT
Poles:	Single and Double



Dimensions: Single pole

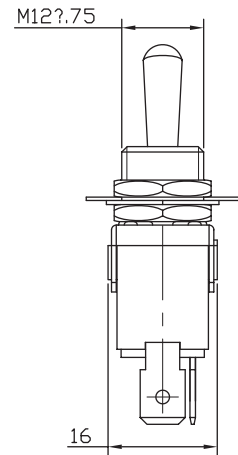
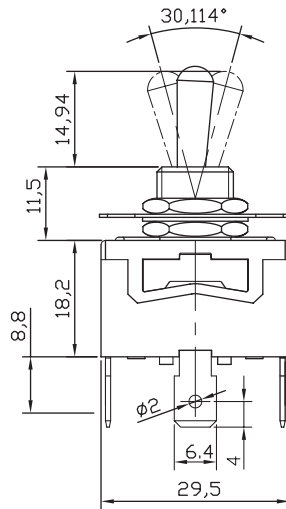
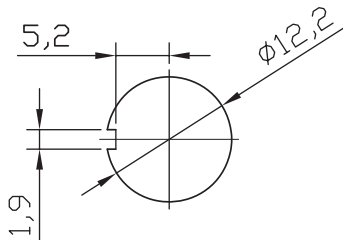

Dimensions: Double pole

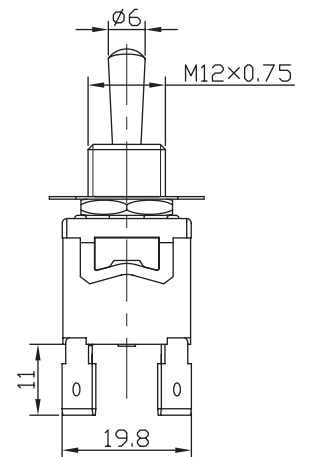
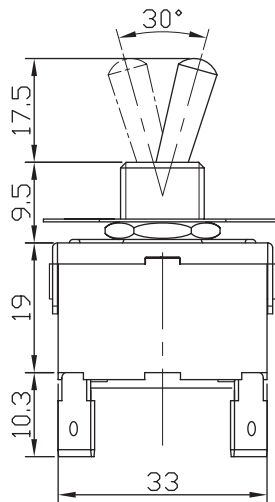
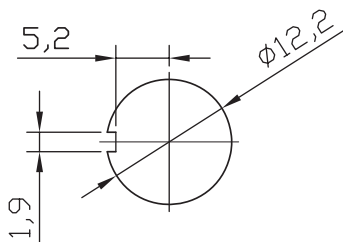

WP-02 - Toggle rubber protection boot switches

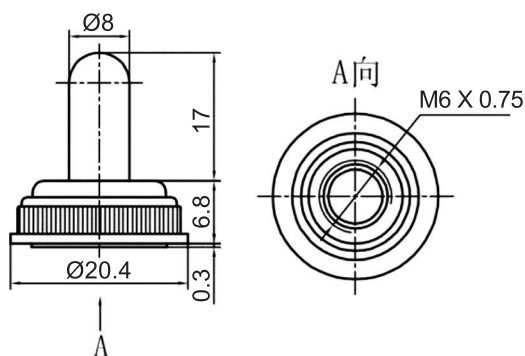

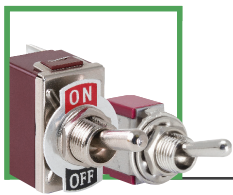

Technical Specifications



MTS series - Miniature toggle switches

Rating:	6A 125 VAC / 3A 250 VAC
Termination:	Solder terminals (W) 2.05 mm
Mounting:	M60.75 threaded collar (mounts through Ø6mm panel hole)
Dielectric strength:	1000VAC (1 minute)
Operating temperature:	-25 to +85°C
Configurations:	On-On, On-Off-On (3 position)
Switch:	SPDT (Single and Double poles)

Dimensions: Single pole

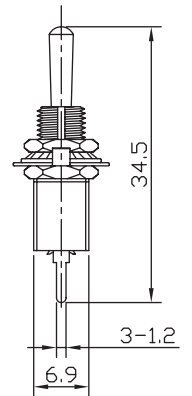
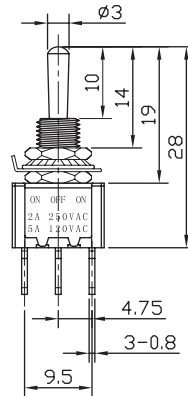
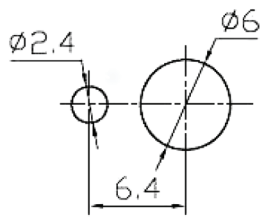

Dimensions: Double pole

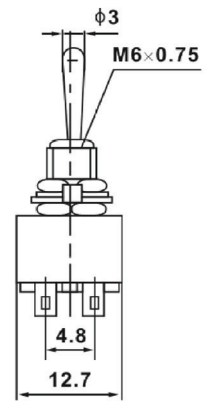
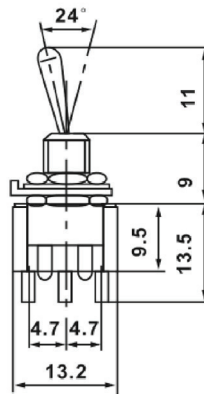
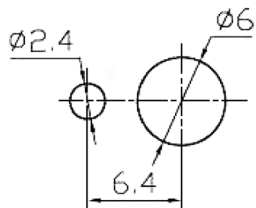

DS-12 Miniature pushbutton switch

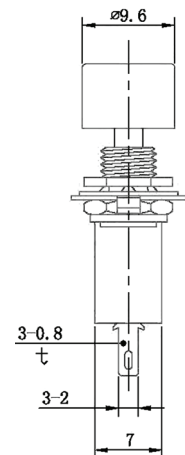
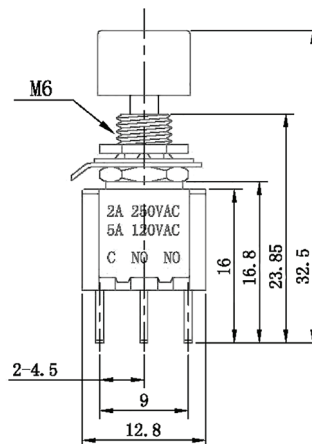
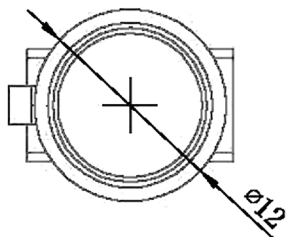

WP-02 - Toggle rubber protection boot switches

